

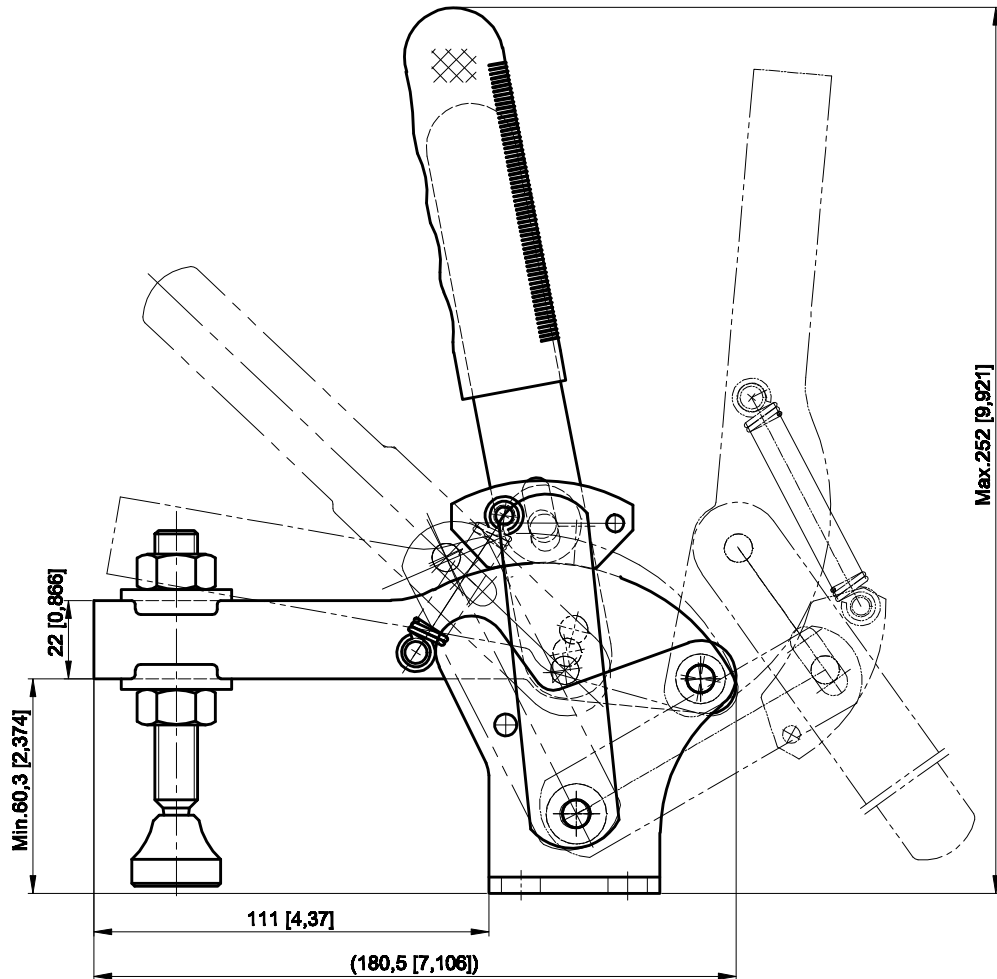

PART NUMBER: CH-60131

WEIGHT(g):1590

HOLDING CAPACITY(kg):350

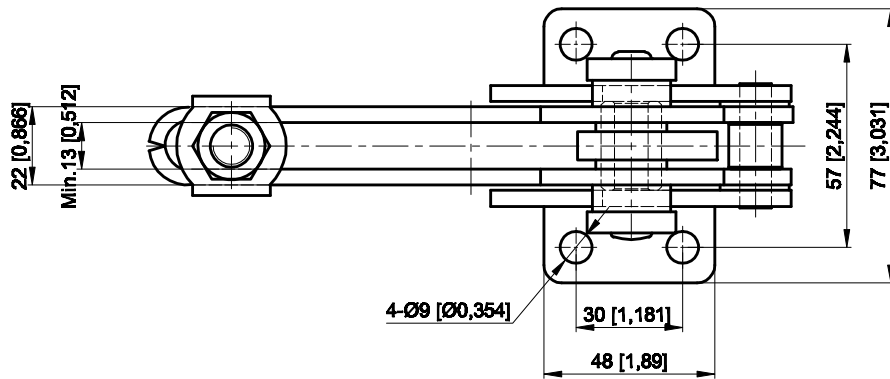

BAR OPENS:85°
HANDLE OPENS:170°
SPINDLE SUPPLIED:CH-SF-12400